

Item	Qty.	Description
1	1	42" h Vertical Extrusion
2	1	42" h Vertical Extrusion
3	1	42" h Vertical Extrusion
4	1	42" h Vertical Extrusion
5	1	23" w Horizontal Extrusion
6	1	23" w Horizontal Extrusion
7	1	29" wx6" h Mounting Plate
8	1	23" w Horizontal Extrusion
9	1	14" Z140 Counter Support
10	1	14" Z140 Counter Support
11	1	Stability Leg Support
12	1	Stability Leg Support

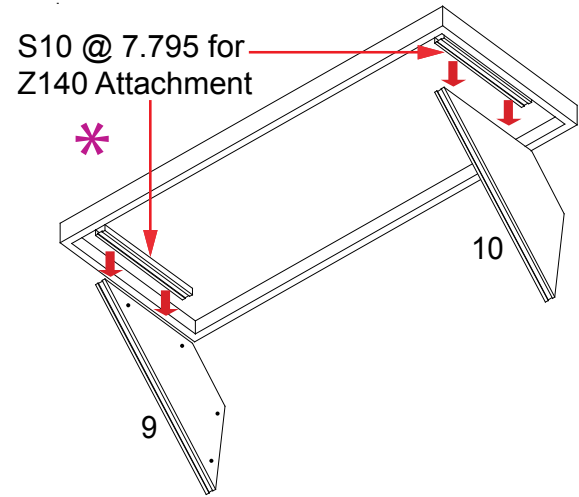

visionaryTM
DESIGNS

Steps:

- 1) Connect vertical extrusions [1 & 2] and [3 & 4] together.
- 2) Attach horizontal extrusions [5, 6, & 8] between vertical assemblies [1/2 & 3/4].
Note: Place infills between horizontal and vertical extrusions as shown.
- 3) Attach stability leg supports [11 & 12] to vertical extrusions [1 & 3].
- 4) Attach vertical extrusions [1 & 3] to wood laminated base using bolts.
- 5) Attach counter supports [9 & 10] to vertical extrusions [1 & 3].
- 6) Place counter top atop counter supports and lock to secure in place.
- 7) Attach mounting plate [7] to vertical extrusions [2 & 4].
- 8) Velcro attach graphic header to verticals as shown.
- 9) Attach cabinet to wood laminated base using bolts and wing nuts. Also attach cabinet with one screw cap to horizontal extrusion [6] at center. Refer to **Cabinet to Horizontal Extrusion Attachment** detail. Note: Cabinet door must be open for cabinet attachment.

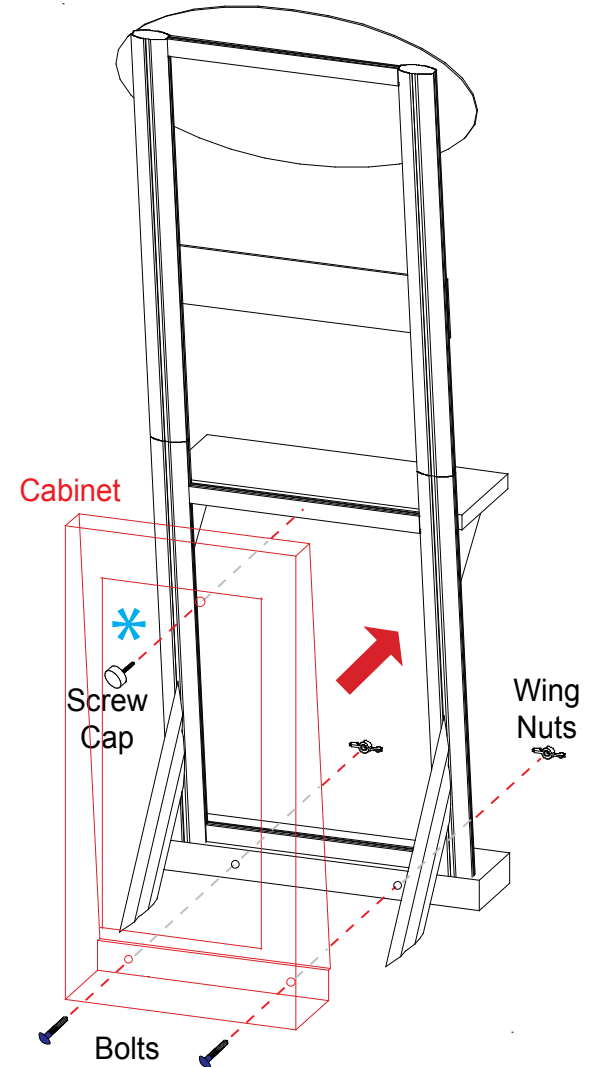
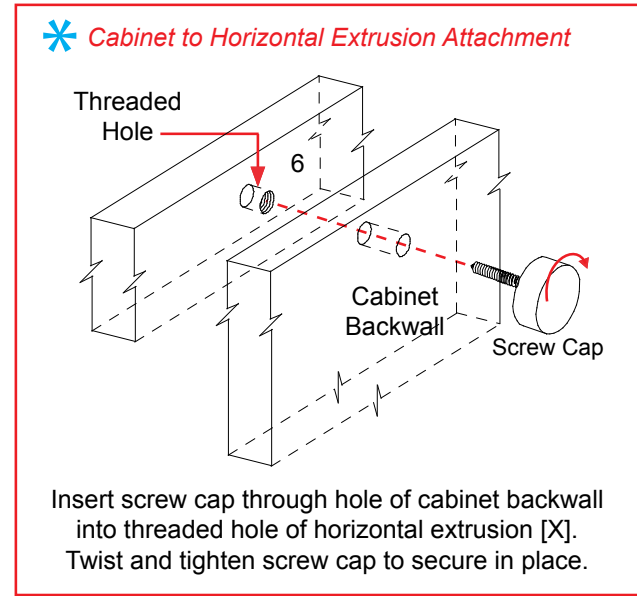
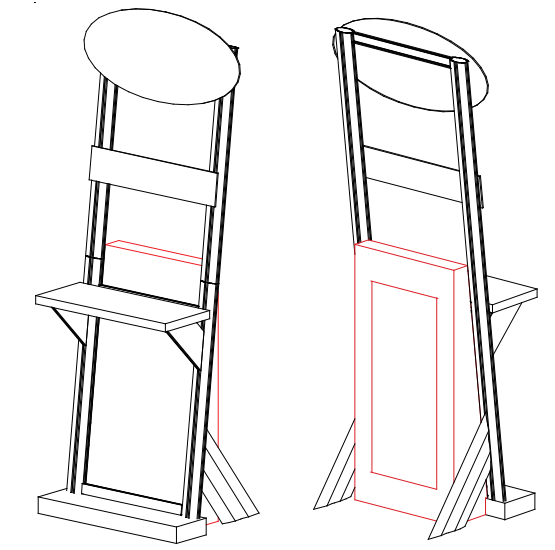
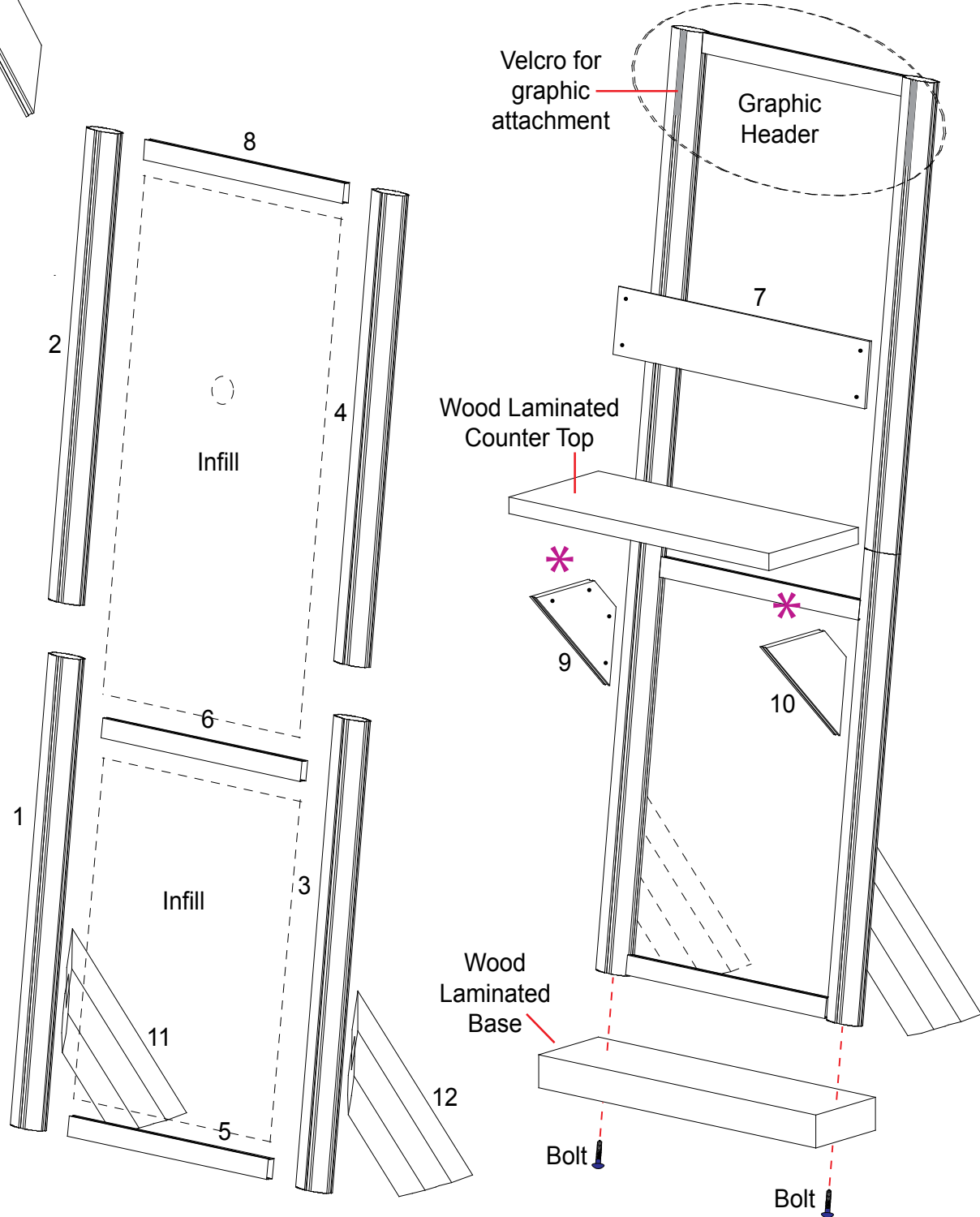

WHEN DISASSEMBLING ALUMINUM EXTRUSION, TIGHTEN ALL SETSCREWS AND LOCKS TO PREVENT LOSS DURING SHIPPING

visionary™ DESIGNS

Using Your Setup Instructions

The Visionary Designs Setup Instructions are created specifically for your configuration. They are laid out sequentially, including an exploded view of the entire display, and then a logical series of detailed steps to assemble the main structure and components. We encourage you to study the instructions **before** attempting to assemble your exhibit.

Each page reminds you to tighten the setscrews after disassembling your exhibit to prevent loss of the locks and setscrews (see below in RED). This is **VERY IMPORTANT**.

Cleaning and Packing Your Display

- 1) Use care when cleaning aluminum extrusion or acrylic inserts. Use only non-abrasive cleaners.
- 2) When cleaning laminate inserts or countertops, use mild cleansers and a soft material such as cotton.
- 3) Keep all display components away from extreme heat and long exposure to sunlight to avoid warping and fading.
- 4) Retain all packing material. It will make re-packing much easier and will reduce the likelihood of shipping damage.



The Tool

Most Visionary Designs exhibits can be assembled with the supplied Hex Key Tool. Occasionally, a flat head screwdriver may be required.



Typical Connection

Most horizontal extrusion connections have a patented expandable lock. This lock inserts into the groove of an opposing extrusion. Tightening the lock with the Hex Key Tool expands the lock and creates a strong positive connection.



Typical Connection (cont'd)

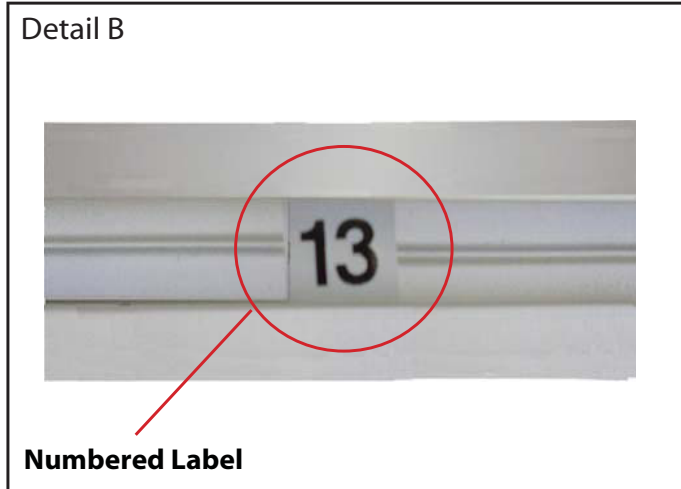

Numbered Label

Each extrusion contains a numbered label which corresponds with setup instructions. The label is located within a groove of the extrusion (when possible). With Visionary Designs the labels contain Black numbers unless otherwise specified.



Horizontal Inline Connection (remove only one setscrew)

Remove only (1) setscrew when disassembling. Replace setscrew in extrusion after assembling it. Before packing, replace setscrew in extrusion to avoid losing it.

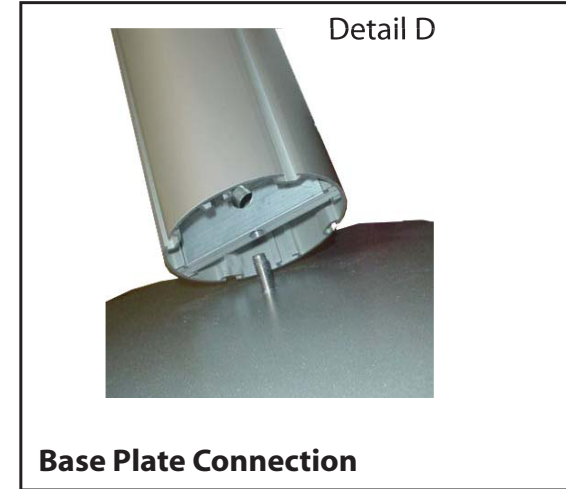

Base Plate Connection

Attach base plate to round or square vertical extrusion using the bolt provided. Be careful not to strip the threads.

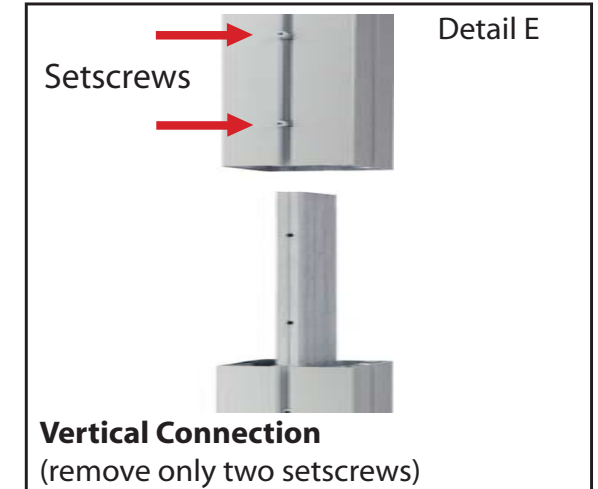

Vertical Connection
(remove only two setscrews)

When vertical extrusions are packed in portable cases rather than crates or tubs, they must be broken down into smaller sections which then require assembly.

Remove only (2) setscrews when disassembling. Replace setscrews in extrusion after assembling it. Before packing, replace setscrews in extrusion to avoid losing them.

WHEN DISASSEMBLING ALUMINUM EXTRUSION, TIGHTEN ALL SETSCREWS AND LOCKS TO PREVENT LOSS DURING SHIPPING

Top View of Each Level

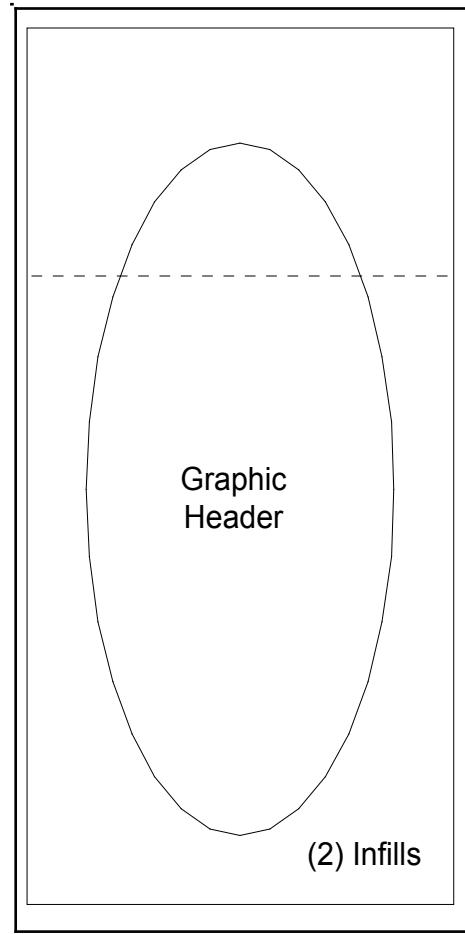

Level 1

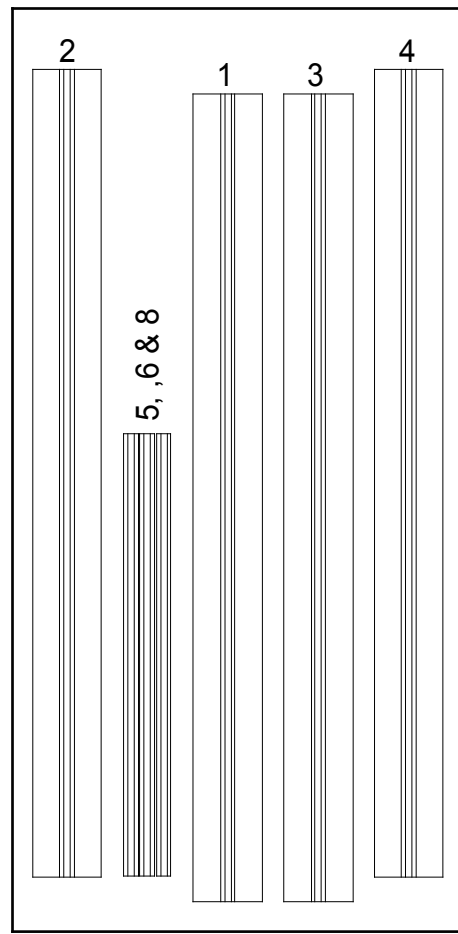

Level 2

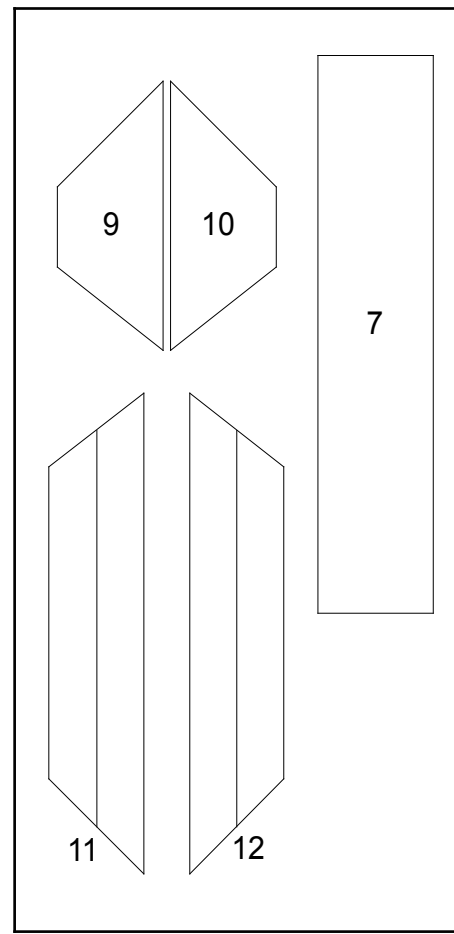

Level 3

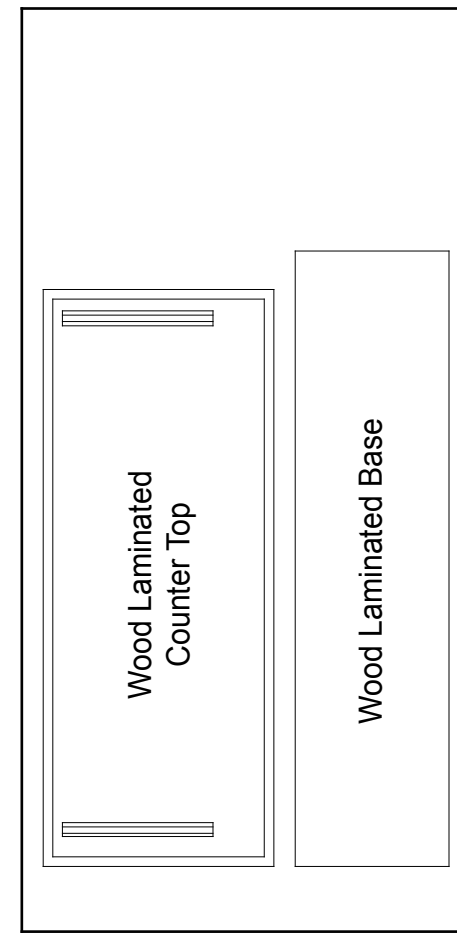

Level 4

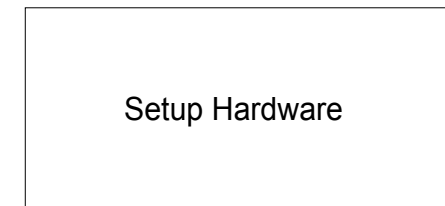

WHEN DISASSEMBLING ALUMINUM EXTRUSION, TIGHTEN ALL SETSCREWS AND LOCKS TO PREVENT LOSS DURING SHIPPING

Top View of Each Level

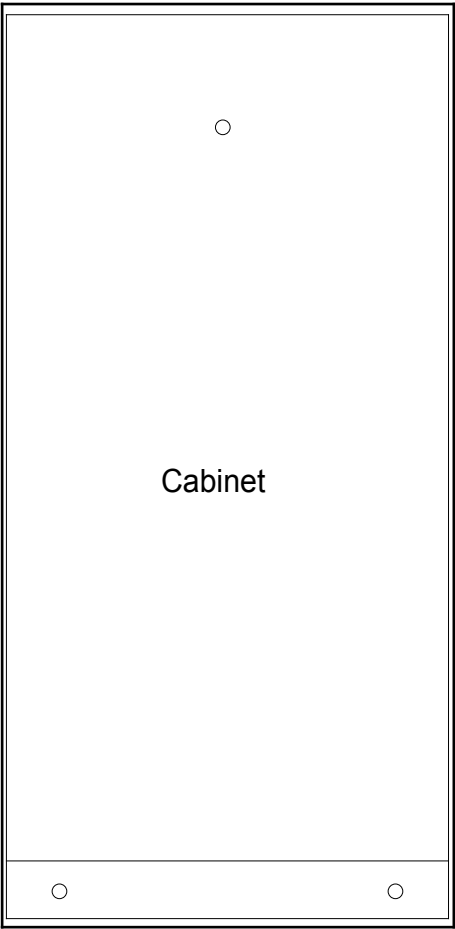

Level 1

WHEN DISASSEMBLING ALUMINUM EXTRUSION, TIGHTEN ALL SETSCREWS AND LOCKS TO PREVENT LOSS DURING SHIPPING